



Nome del prodotto

Estrattore interno a 2 strati

Per l'estrazione di cuscinetti interni, anelli di cuscinetti e bocche.

Num. art. 21-9

Serie 21

EAN 4021176011986



Attributo tecnico

Metrico

Imperiale



Cuscinetto a sfera ISO

6014; 6214; 6314;	6014; 6214; 6314;
16014; 6015; 6215;	16014; 6015; 6215;
6315; 16015; 6016;	6315; 16015; 6016;
6216; 6316; 16016;	6216; 6316; 16016;
61816; 6017; 6217;	61816; 6017; 6217;
6317; 6018; 6218;	6317; 6018; 6218;
6318; 16018; 61818;	6318; 16018; 61818;
6219; 6319; 6020;	6219; 6319; 6020;
6220; 6320; 16020;	6220; 6320; 16020;
61820	61820



Diametro interno del cuscinetto a sfere

70 - 100 mm

2 3/4 - 3 7/8 inch



Profondità di inserimento

95 mm

3 3/4 inch



Lunghezza estrattore interno

166 mm

6 1/2 inch



Numero di segmenti

2

2



Peso

2.9 kg



esige anche

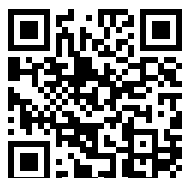

Dispositivi battenti

22-0-1

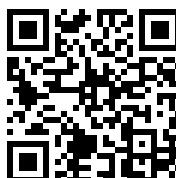

Controsupporti

22-3



Viene utilizzato da

Num. art.

Nome del prodotto

22-3

Controsupporti

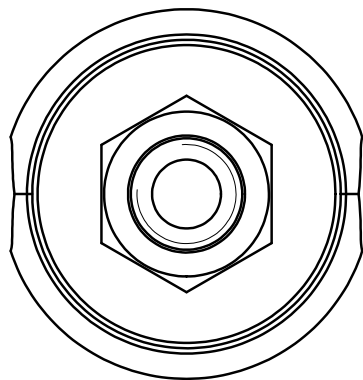
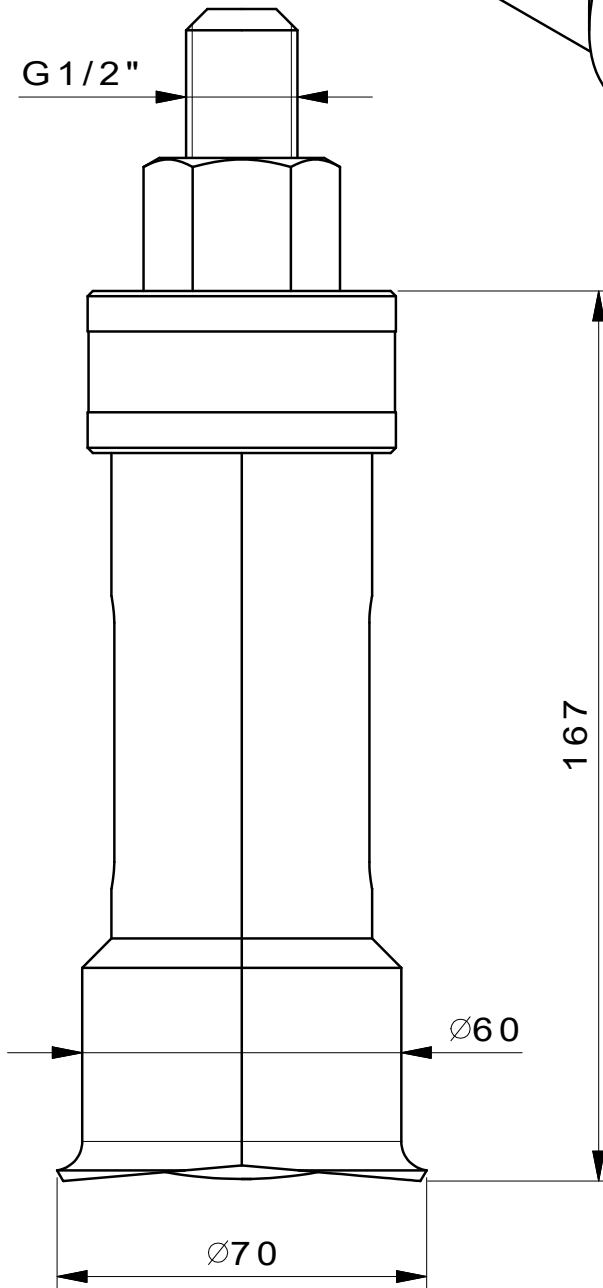
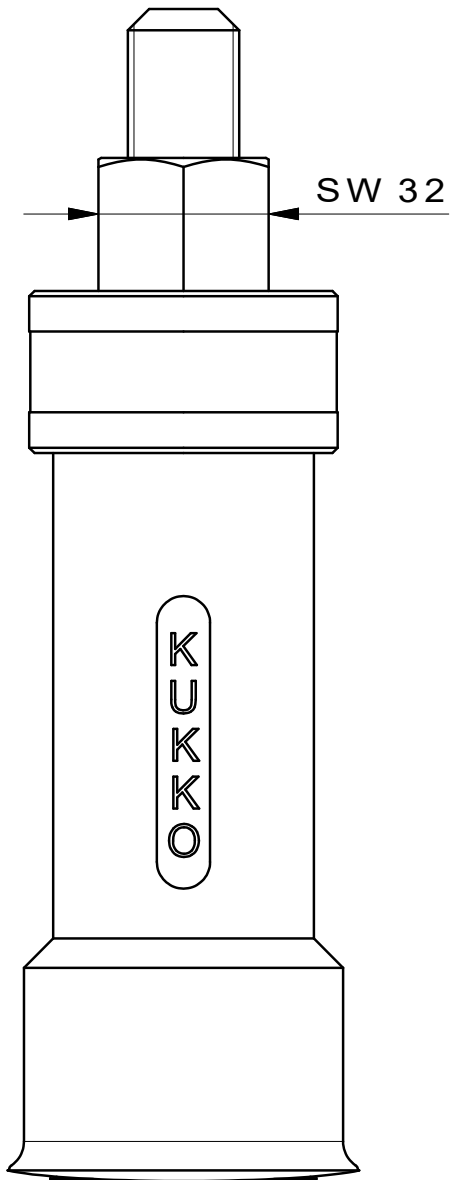
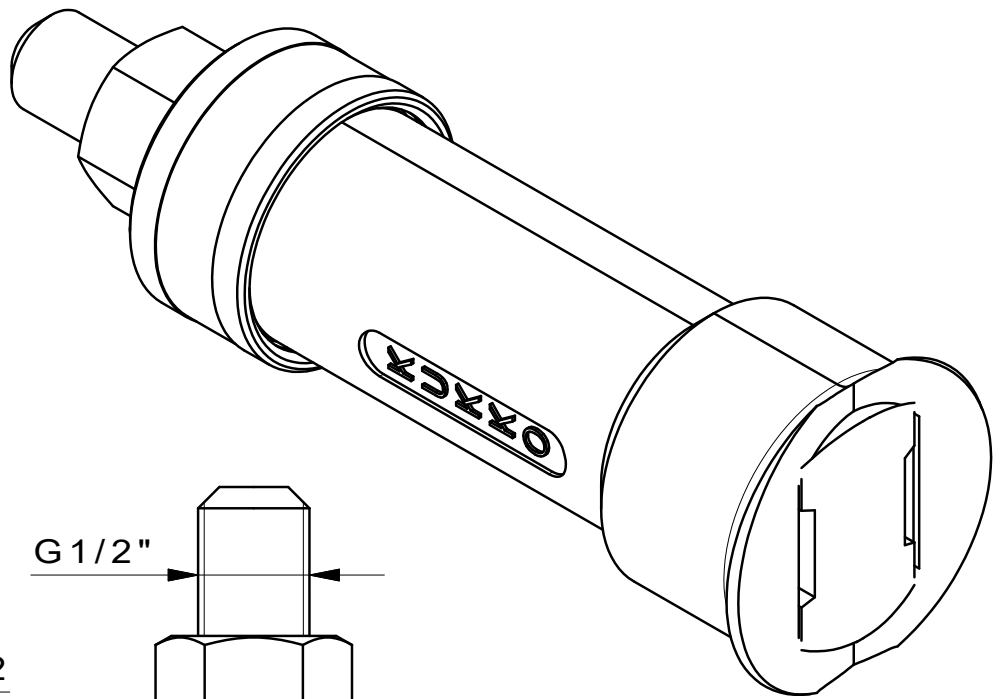
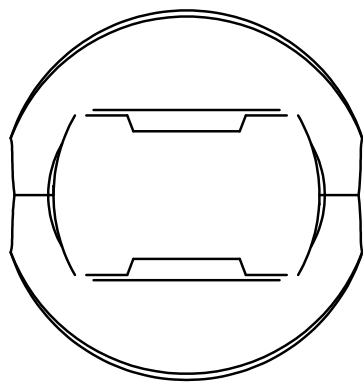

 Kleinbongartz & Kaiser oHG Werkzeugfabrik Hilden - Germany	Dokumentname: 21-9 Innenauszieher	Toleranz: DIN ISO 2768-m
	Dokumentbeschreibung: ZSB	Material: Hochfester extra zäher Vergütungsstahl/ High tensile strength and toughness steel
Erstellt / Geprüft von: Schultes	Erstellungsdatum: 05/06/2015	Maßstab: 1:1
Teilbeschreibung: Innenauszieher/ Internal extractor		Wärmebehandlung / Härte: vergüteter Stahl/ tempered steel
Oberflächenbehandlung:		
Artikelnummer / ZNR.: 21-9	Dokumentversion: -	Schutzvermerk ISO 16016 beachten